

安装示意图 Installation diagram

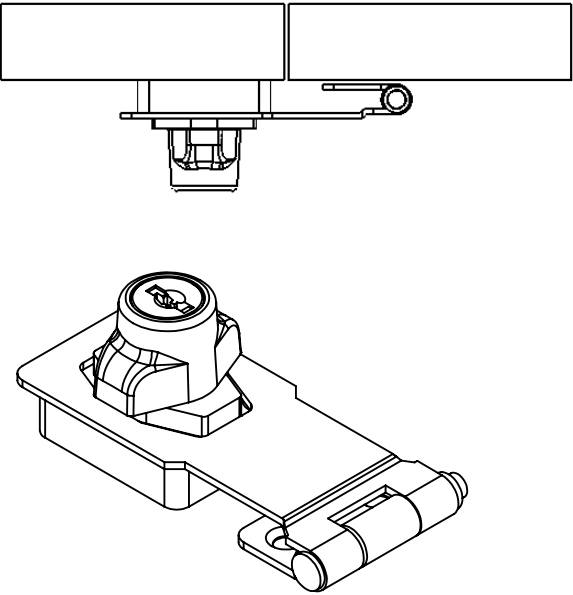
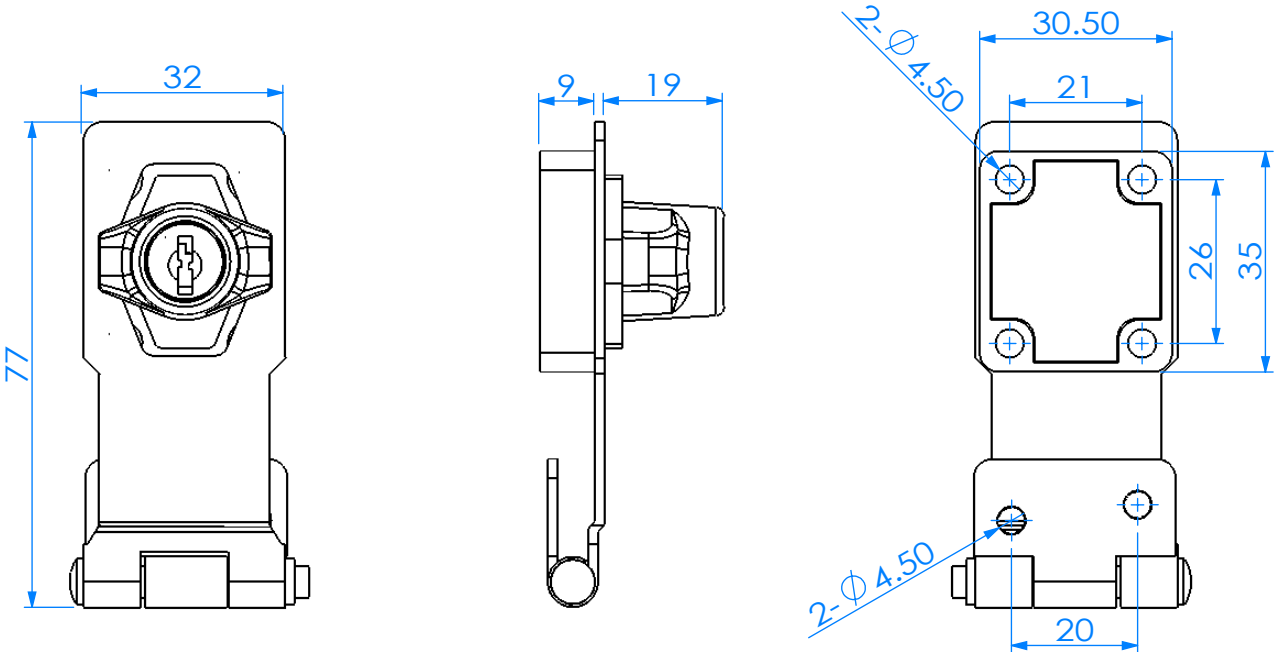

参考开孔尺寸
Refers to the hole size

规格参数表 Specification			可选配件 Selected accessories			
Model	D	L				
3810						

转动方向 Core turn direction

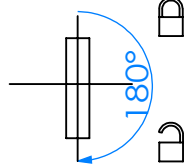

381

Version
A0

WUIKAI LOCKS Manufactory Ltd.