

安装示意图 Installation diagram

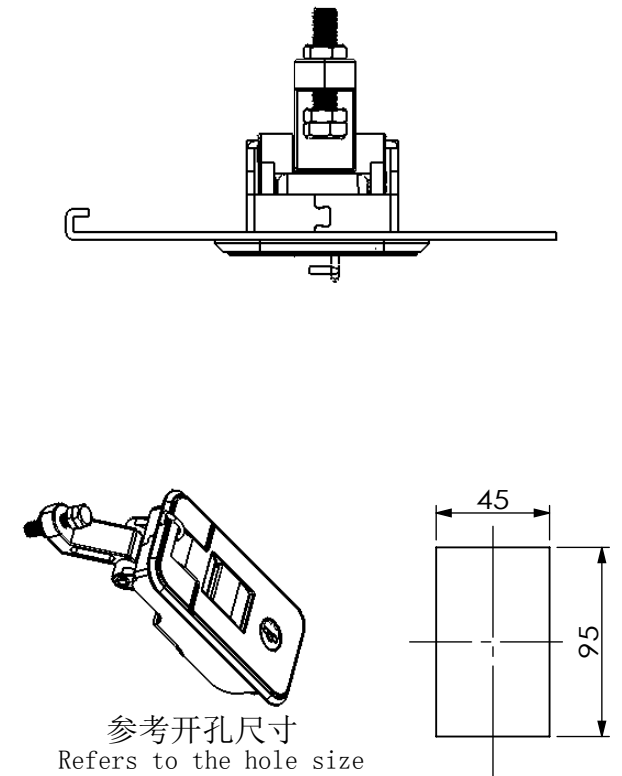

参考开孔尺寸  
Refers to the hole size

规格参数表  
Specification

可选配件 Selected accessories

Model	D	L
2970		

转动方向 Core turn direction

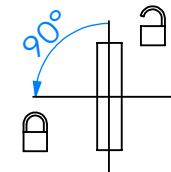

2970

Version
A0

WUIKAI LOCKS Manufactory Ltd.