

安装示意图 Installation diagram

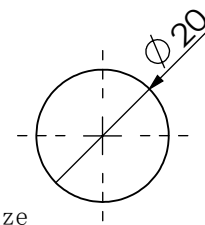
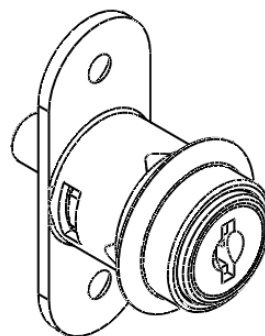
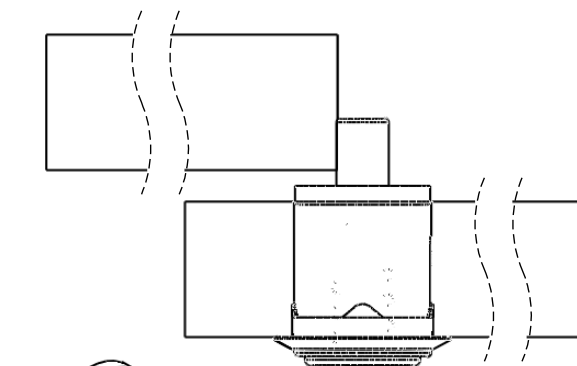
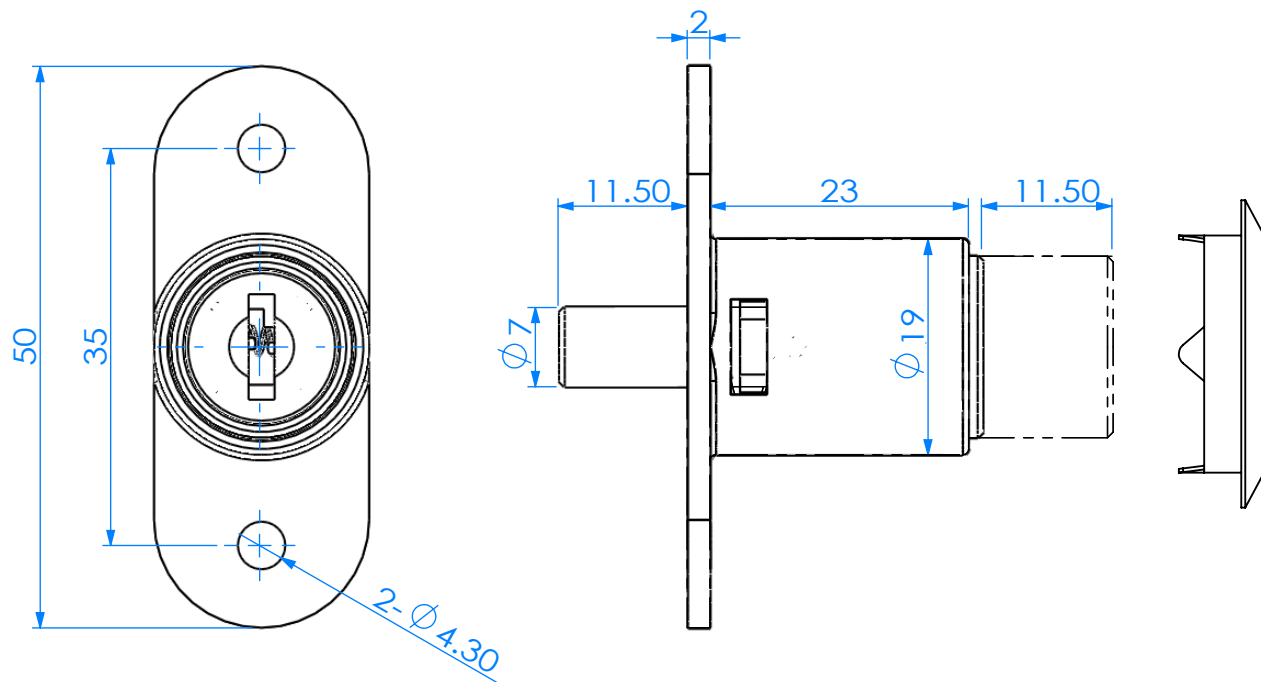

参考开孔尺寸  
Refers to the hole size

可选配件 Selected accessories

A1002

A1009

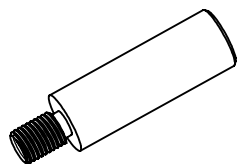
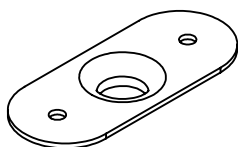

转动方向 Core turn direction

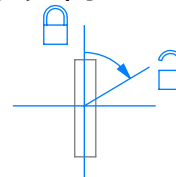

105

Version  
A0

WUIKAI LOCKS Manufactory Ltd.

规格参数表  
Specification

Model	D	L
1050	19	23